

SHOP

allestimento & arredamento

IT tutto e ancor di più per l'allestimento di negozi e per eventi: mobili completi, accessori e complementi modulari per l'arredo e l'allestimento creativo

ladenbau & einrichtung

DE alles für die komplettausstattung von shops wie events: fertiges mobilar, zubehör und modulare komponenten für die ganz individuelle einrichtung und den kreativen ladenbau.

shop fittings & interiors

EN all for the complete fitting of shops and events: ready to use furniture, accessories and modular components for very individual interiors and the creative shop fitters



soistes general information 242-245	soistes ideas 246-247	soistes components 248-249	soistes bases accessories 250-253	soistes trays 252-253	connector 254	global soistes nut 255	soistes accessories 256

soistes freepad 257	pole soistes 258-259	soistes accessories 260-263	cart soistes 264	cage soistes 265	ripiano 266	sarto soistes 267	store soistes 267

silentART 268-269	vetrina top 270	vetrina 271	connector 272	space 273	miura stool & table 274	rondo 275	ping meets pong 275



soistes®
italian design by KD

MADE IN EU design by KD patented

PROFILE YOURSELF!®



IT questo sistema, tanto semplice quanto geniale, è nato dalle sollecitazioni che ci presenta l'architettura moderna, con i suoi vasti open space realizzati in vetro e in metallo: per queste esigenze c'è bisogno di un sistema universale e completo, che sia modulare e che si possa utilizzare come allestimento autoportante o mobile, avendo allo stesso tempo la possibilità di essere applicato a parete e a soffitto. deve essere inoltre un sistema elegante e trendy che permetta di arredare gli spazi vuoti e di rappresentare uno strumento di presentazione, facile e veloce da montare. sembra quasi la quadratura del cerchio? sì, è proprio SOISTES (che significa „é così“) venite a scoprire nelle prossime pagine tutto quello che potrete creare con le strutture soistes.

DE geboren ist dieses einfache wie geniale system aus der herausforderung, die uns moderne architektur mit ihrem grosszügigen open space in glas und metall stellt: hier braucht es ein durchgängiges und universelles system, das sich modular freistehend oder mobil aufbauen lässt und zudem für die wand- und deckenmontage geeignet ist. es soll ausserdem trendiges ambiente für einrichtung wie präsentation bieten und dennoch schnell und unkompliziert zu montieren sein. fast schon die quadratur des kreises? ja, genau SOISTES! entdecken sie auf den folgenden seiten was und wieviel sie mit soistes strukturen alles realisieren können.

EN this simple but ingenious system was born out of the challenges that modern architecture gives us, with its huge open spaces in metal and glass: the need for a universal system, that can be freestanding or mobil, that can be mounted to the wall or suspended from the ceiling, that creates a trendy ambience for interior decoration and presentation as well and that can be mounted quickly and easily. in short: a solution of striking simplicity for complex and multiple demands, which we called SOISTES. discover on the following pages what and especially how much you can realize with soistes structures.

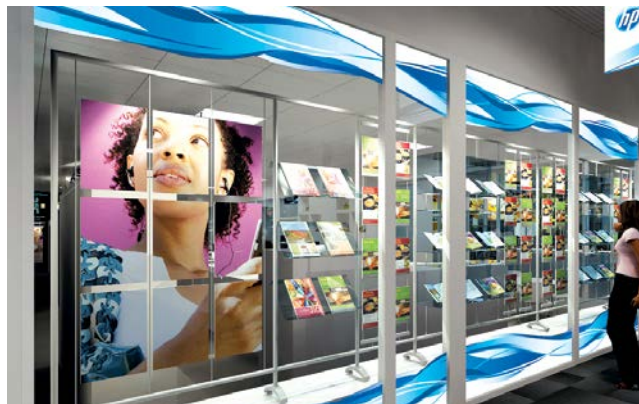



profile yourself®

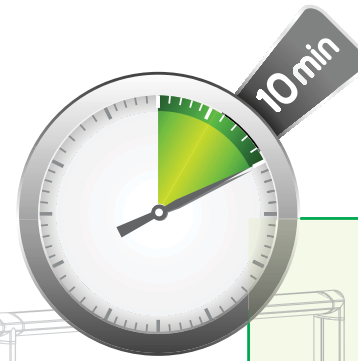

i connettori angolari costituiscono le giunzioni per costruire la struttura base .
 mit den eckverbindern wird die grundstruktur aufgebaut.
 the basic structure is assembled using edge connectors.

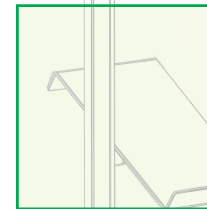
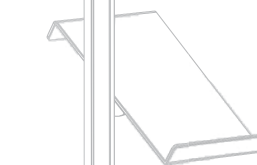
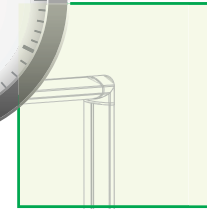

dadi filettati per montare i ripiani regolabili in inclinazione ed altezza.
 mutsteine mit gewinde für die ablagenmontage, stufenlos höhenverstellbar.
 threaded nuts for the mounting of the trays, adjustable in height and inclination.

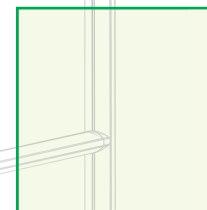
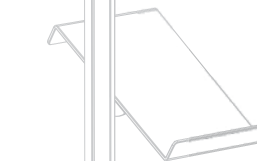

semplice e sicuro il montaggio delle traverse per una perfetta stabilità .
 einfache querstrebenmontage sorgen für hohe stabilität.
 easy to mount cross braces give high stability

soistes®

italian design by KD

MADE IN EU design by KD patented

IT i nuovi trend e le richieste del mercato oggi influenzano sempre di più l' arredamento e gli allestimenti in genere. questo richiede un sistema dinamico che si adegui in modo flessibile, rapido e funzionale. soistes è semplice da montare e si adatta a tutte le esigenze dello spazio che ha intorno. i materiali selezionati sono resistenti all' utilizzo quotidiano il tutto senza tralasciare una cura estetica moderna ed elegante. prendete spunto dai prodotti standard della linea soistes per approfondire la gamma attraverso un sistema modulare per l'arredo con il quale realizzerete le vostre idee.

DE ladenbau wie einrichtung unterliegen immer schneller neuen trends und marktforderungen. hier ist ein system gefordert, das schnell, flexibel und anpassungsfähig ist. soistes ist nicht nur einfach aufzubauen, es passt sich auch räumlichen gegebenheiten an. die ausgesuchten materialien halten täglichen belastungen stand und sind dennoch leicht in ihrer anmutung. abgesehen von den fertigmodulen, bietet soistes ihnen die ganze palette eines modularen baukastensystems, mit dem sie ihre einrichtungsideen im handumdrehen realisieren.

EN shop fitting and interiors vary according to new trends and market needs. this requirement asks for a system that is quick, flexible and can be applied to any situation. not only is soistes easily assembled, but it also adapts well to surrounding spatial needs. the materials selected withstand daily usage while still looking stylish and modern. in addition to the standard ready made articles, the soistes range gives you all of the advantages of a modular system, turning your ideas easily into reality.

information

richiedete adesso il vostro catalogo!

nel nostro nuovo catalogo troverete informazioni esaurienti su tutto ciò che potrete realizzare con soistes

bestellen sie jetzt ihr exemplar!

ausführliche info und was sie alles mit soistes noch machen können, finden sie im neuen katalog

order your copy now!

for detailed information and what else you can do with soistes, is all in the new catalogue



soistes® ideas

Italian design by KD

MADE IN EU design by KD patented



IT nelle pagine seguenti troverete tutti gli accessori necessari quali profili, connettori, angolari, piedini di appoggio, ruote e basi per la libera composizione della vostra personalissima struttura soistes. nell'ultima parte di questa sezione troverete inoltre la gamma completa di ripiani, scaffali, portaoggetti, portaposter e sistemi di fissaggio a disposizione per il completamento delle vostre creazioni con soistes.

DE auf den folgenden seiten finden sie alle erforderlichen profile, eckverbinder, füsse, rollen und basen für den bau ihrer ganz persönlichen soistes struktur. und im letzten teil gibt es alle ablagen, fachböden, objektträger, postertaschen und die erforderlichen befestigungen für sie zur auswahl.

EN on the following pages you find all the single components such as extrusions, edge connectors, feet, wheels and bases to set up your very own soistes structure. and in the last chapter you find a large variety of shelves, boards, trays, poster pockets and the required mounting supports for you to choose from.

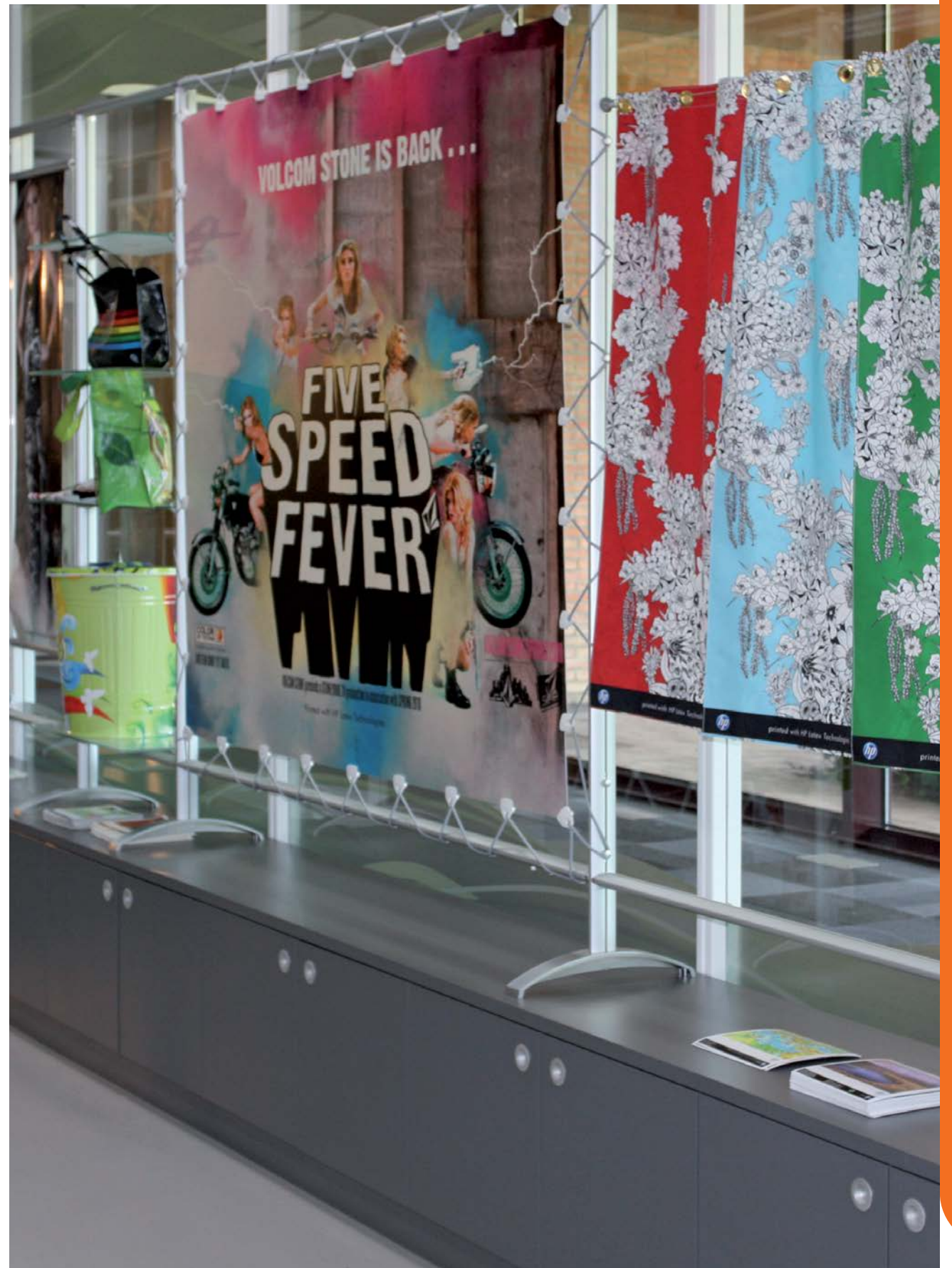

soistes® components

MADE IN EU design by KD **patented**



IT grazie a questi moduli pre-assemblati, la creazione ed il montaggio di strutture base soistes sono davvero semplici e veloci: basterà scegliere l'altezza e la larghezza, il tipo di terminale e il gioco é fatto. (frame A: montante e frame B: traversa).

DE mit diesen bereits abgelängten und mit verbindern vormontierten profil-O-modulen ist der aufbau der soistes grundstruktur ganz unkompliziert: einfach gewünschte höhe und breite sowie art des oberen eck-abschlusses (frame A überstehend, frame B bündig) auswählen.

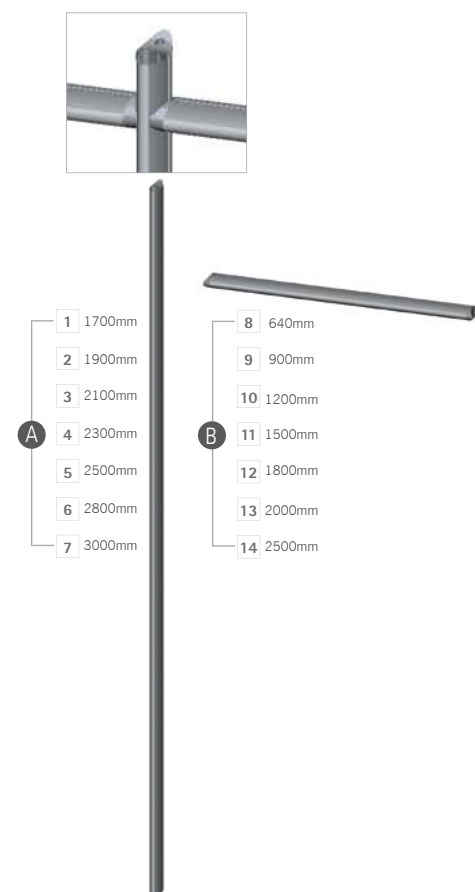
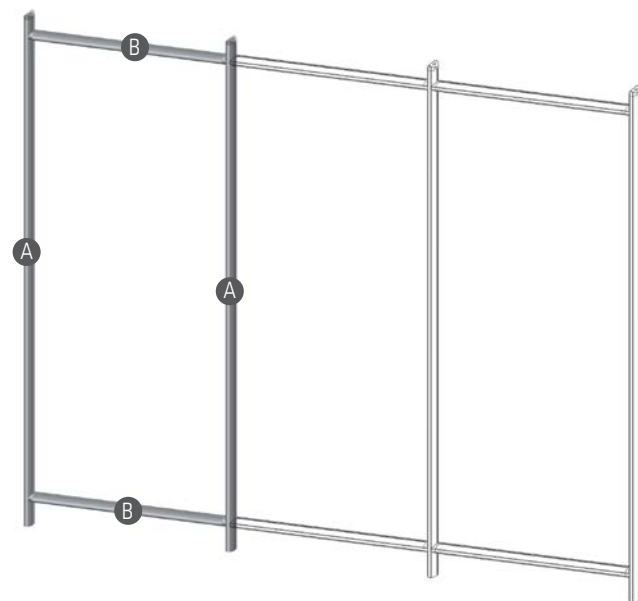
EN with these pre-cut extrusion modules and with connectors preassembled, the set up of the soistes basic structure is really convenient and easy: just choose the required height and width and which kind of corner connection (frame A overlying, frame B flush).





FRAME A

included  

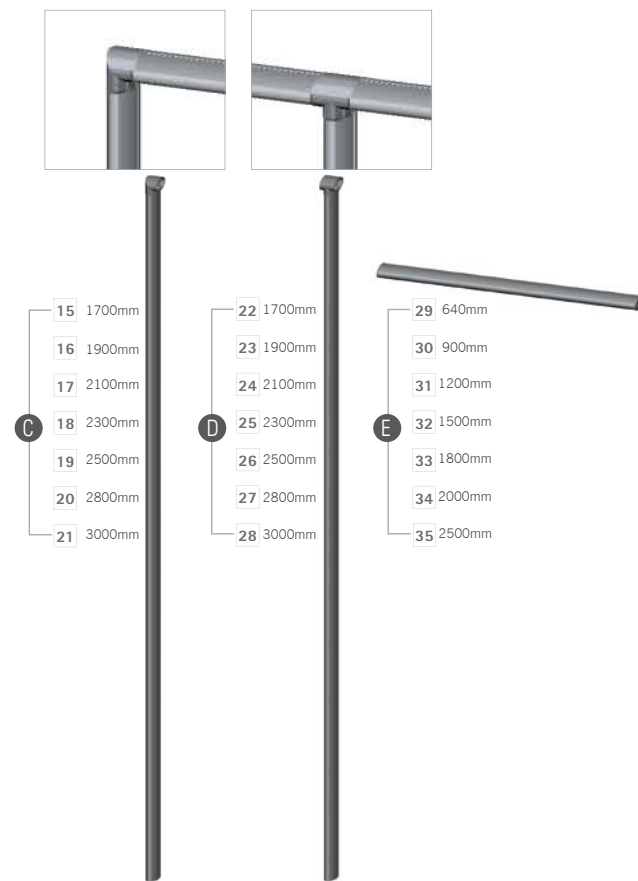
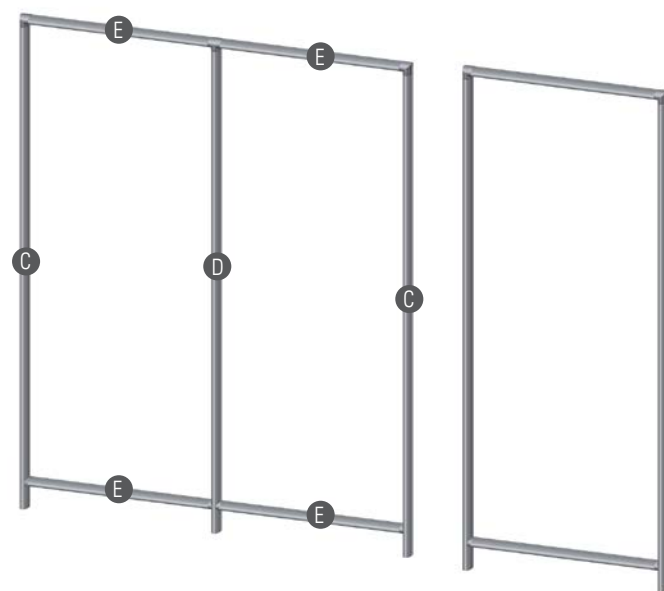
1	SOFA1700V	frameA V 1700mm,1pc	
2	SOFA1900V	frameA V 1900mm,1pc	
3	SOFA2100V	frameA V 2100mm,1pc	
4	SOFA2300V	frameA V 2300mm,1pc	
5	SOFA2500V	frameA V 2500mm,1pc	
6	SOFA2800V	frameA V 2800mm,1pc	
7	SOFA3000V	frameA V 3000mm,1pc	
8	SOFAB640Q	frameA/B Q 640mm, 1pc	
9	SOFAB900Q	frameA/B Q 900mm, 1pc	
10	SOFAB1200Q	frameA/B Q 1200mm, 1pc	
11	SOFAB1500Q	frameA/B Q 1500mm, 1pc	
12	SOFAB1800Q	frameA/B Q 1800mm, 1pc	
13	SOFAB2000Q	frameA/B Q 2000mm, 1pc	
14	SOFAB2500Q	frameA/B Q 2500mm, 1pc	



FRAME B

included  

15	SOFB1700VE	frameB VE 1700mm, 1pc	
16	SOFB1900VE	frameB VE 1900mm, 1pc	
17	SOFB2100VE	frameB VE 2100mm, 1pc	
18	SOFB2300VE	frameB VE 2300mm, 1pc	
19	SOFB2500VE	frameB VE 2500mm, 1pc	
20	SOFB2800VE	frameB VE 2800mm, 1pc	
21	SOFB3000VE	frameB VE 3000mm, 1pc	
22	SOFB1700VM	frameB VM 1700mm, 1pc	
23	SOFB1900VM	frameB VM 1900mm, 1pc	
24	SOFB2100VM	frameB VM 2100mm, 1pc	
25	SOFB2300VM	frameB VM 2300mm, 1pc	
26	SOFB2500VM	frameB VM 2500mm, 1pc	
27	SOFB2800VM	frameB VM 2800mm, 1pc	
28	SOFB3000VM	frameB VM 3000mm, 1pc	
29	SOFB640Q	frameB Q 640mm, 1pc	
30	SOFB900Q	frameB Q 900mm, 1pc	
31	SOFB1200Q	frameB Q 1200mm, 1pc	
32	SOFB1500Q	frameB Q 1500mm, 1pc	
33	SOFB1800Q	frameB Q 1800mm, 1pc	
34	SOFB2000Q	frameB Q 2000mm, 1pc	
35	SOFB2500Q	frameB Q 2500mm, 1pc	

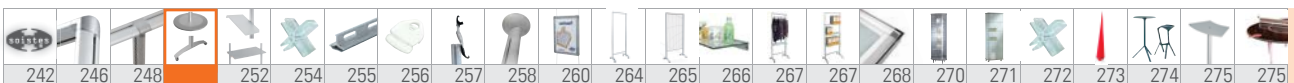

soistes® bases

11 base 330
base con rivestimento esterno di protezione in ABS, color argento, inserto decorativo in alluminio anodizzato, color argento
versilberter abs-trittschutzring mit silber eloxierter aluminium-dekorscheibe
silver-plated abs-step-on-protection ring, silver anodised aluminium decorative inlay

12 base 240
base con rivestimento esterno di protezione in ABS colore grigio, inserto decorativo in alluminio anodizzato, color argento
grauer abs-trittschutz-ring mit silber eloxierter aluminium dekor-scheibe
grey abs-step-on-protection ring with silver anodised aluminium decorative inlay

13 base eco
base in abs, grigio chiaro
lichtgraue abs-kunststoff-basis
light-grey synthetic base

14 plug
piedini di appoggio in gomma rigida, nera, con perno filettato
hartgummi-fuss, schwarz mit gewinde
hard rubber foot, black with thread

15 piede
base realizzata in metallo a pressofusione color argento, con appoggi antiscivolo, nero
fuss aus versilbertem metall-druckguss, mit schwarzen anti-rutsch pads aus kunststoff
foot made of silver-plated metal die-cast, with black anti-slip pads

16 roller 35
ruota doppia nera in PA ricoperta in TPU ø35mm, per montaggio con base piede
leichtlaufrollen aus PA schwarz ø35mm, TPU auflage, zur montage auf fuss piede
smooth wheels in black PA ø35mm with TPU overlay, for mounting to the base piede

17 pad
piedini di appoggio in gomma rigida nera, per il montaggio con la base piede
hartgummi-fuss schwarz, zur montage auf fuss piede
hard rubber foot, black, for mounting to the base piede

18 roller 40
ruota doppia ricoperta in TPU ø40mm, 2 con e 2 senza frena, montaggio con base piede
leichtlaufrollen ø40mm, TPU auflage, 2 mit und 2 ohne bremsen, montage auf fuss piede
smooth wheels ø40mm with TPU overlay, 2 with and 2 without brake, for base piede

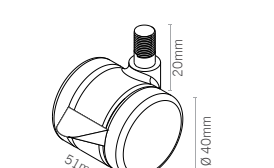
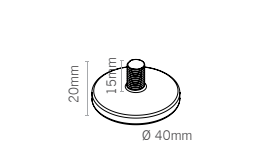
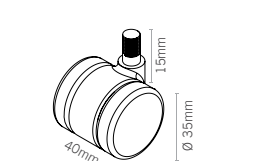
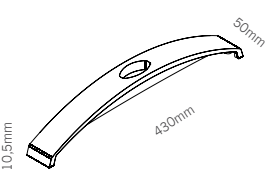
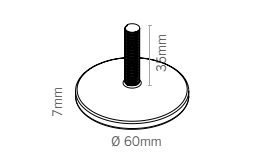
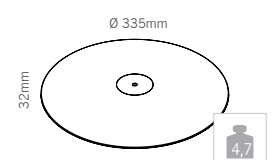
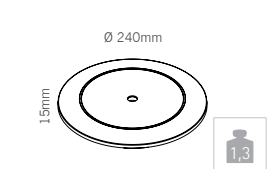
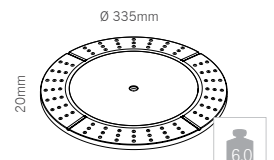

soistes components

11	SOBS330AR	base 330, 1pc	
12	SOBS240	base 240, 1pc	
13	SOEB330GR	base eco, 1pc	
14	SOPU60SZ	plug, box 4pcs	
15	SOP1430AR	piede, 1pc	
16	SOR035	roller ø35mm, box 4pcs	
17	SOPD40SZ	pad, box 4pcs	
18	SOR040	roller ø40mm, box 2x2pcs	

soistes® accessories

1 pinza
supporto per il montaggio laterale del ripiano tray 4 S, realizzato in metallo a pressofusione, color argento.
halter für tray 4 S bei lateraler befestigung. versilberter metall-druckguss.
support for lateral mounting of tray 4 S. silver-plated metal die-cast.

2 peg
supporto a parete per o-profil, distanza dal muro 75mm, realizzato in metallo a pressofusione, color argento.
wandhalter für o-profil wandabstand 75mm. versilberter metall-druckguss.
wall support for o-profil with wall distance 75mm. silver-plated metal die-cast

3 palm
supporto inclinabile per ripiani realizzato in metallo a pressofusione, color argento.
ablagenhalter, drehbar, versilberter metall-druckguss.
tray-support, inclinable, silver-plated metal die-cast

4 hold
supporto per ripiani realizzato in metallo a pressofusione, color argento.
ablagenhalter, versilberter metall-druckguss.
tray-support, silver-plated metal die-cast

5 wing
supporto per ripiani in metallo pressofuso color argento, con elastici di silicone; il ripiano si appoggia sul supporto e resta stabile grazie al proprio peso e al carico.
ablagenhalter, versilberter metall-druckguss, mit gummititze, ablagen einfach auflegen, hält durch eigengewicht.
tray support, silver plated die-cast metal, with rubber protection. simply add the tray, stable thanks to tray's own weight and load.

6 arm
sostegno a parete per o-profil, distanza dal muro 206mm, realizzato in metallo a pressofusione, color argento
wandhalter für o-profil wandabstand 206mm. versilberter metall-druckguss.
wall support for o-profil with wall distance 206mm. silver-plated metal die-cast

7 ofix
sostegno a parete per o-profil, da combinare con arm
wandhalter für o-profil in kombination mit befestigung arm.
wall support for o-profil, in combination with support arm

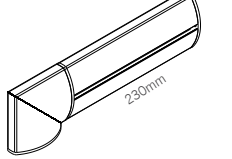
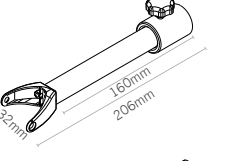
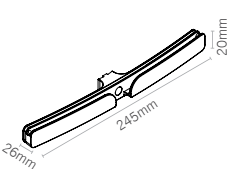
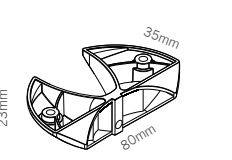
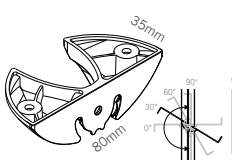
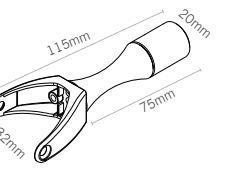
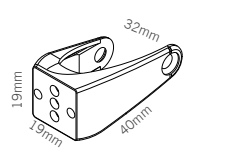

included

combinations

included

combinations

included

combinations

included

combinations

included

combinations

included

combinations

included

combinations

soistes accessories

1	SOPZ1940AR	pinza, 1pc	
2	SOPG32115AR	peg, 1pc	
3	SOPM8035AR	palm, 1pc	
4	SOH08035AR	hold, 1pc	
5	SOWI02	wing, 2pcs	
6	SOAR32206AR	arm, 1pc	
7	SOWHOP162	ofix, 1pc	

soistes® trays



1 tray A4
 ripiano A4, policarbonato stampato ad iniezione, montaggio laterale singolo o doppio.
A4 ablage aus schlagfestem poly-carbonat spritzguss für seitliche, ein- und beidseitige montage
single tray made of shock-resistant polycarbonate die-cast for DIN A4 format. for lateral single or double sided mounting.

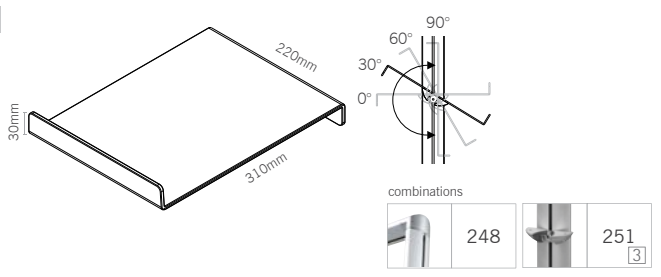

2 tray A4S
 ripiano A4, policarbonato stampato ad iniezione, supporto in alluminio anodizzato per montaggio frontale su o-profil incluso.
A4 ablage aus schlagfestem polycarbonat spritzguss incl. silber eloxiertem aluminium halter für frontale montage auf o-profil.
A4 tray made of polycarbonate die-cast incl silver anodised support for front mounting to o-profil.

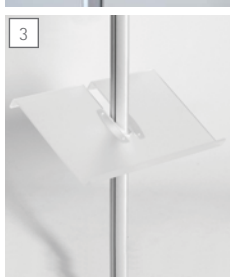
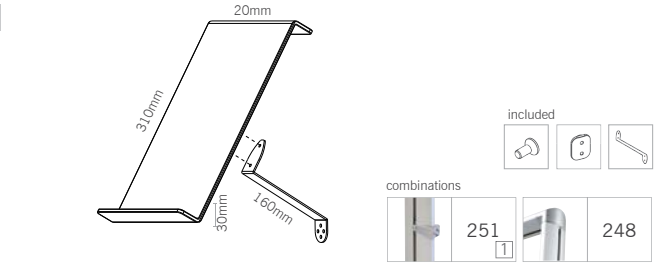

3 tray 2A4
 ripiano in acrilico satinato per 2 formati DIN A4 verticali
ablage aus satiniertem acryl. für 2 DIN A4 formate.
tray made of satin acrylic. for 2 DIN A4 format.

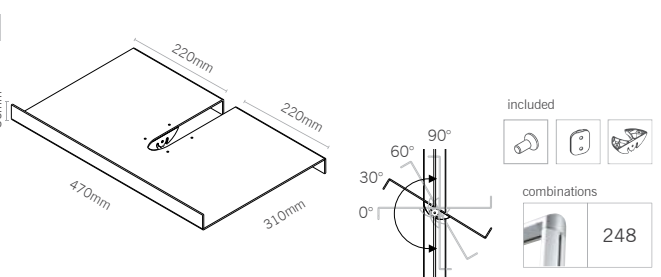

4 tray 650x310mm
 ripiano in acrilico satinato per 3A4 verticali, per giornali o riviste di formato più grande.
ablage aus satiniertem acryl für 3 A4 oder grossformatige zeitung.
tray made of satin acrylic, place for 3 A4 formats or large format newspapers.

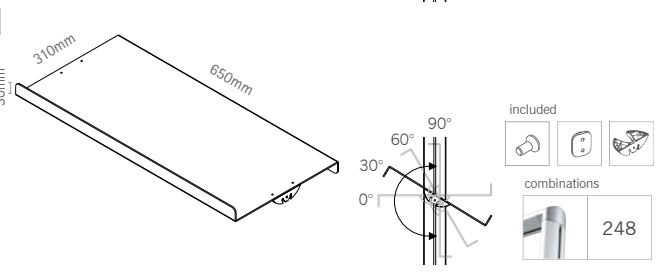

5 tray 650x360mm
6 tray 910x360mm
 ripiano in vetro temperato, spessore 8mm. fondo satinato e con il marchio. disponibile in due misure
fachboden aus temperiertem 8mm starkem glas. unterseite satiniert mit markenzeichen. 2 grössen zur auswahl.
shelf made of tempered 8mm thick glass. rear side satined and brand marked. available in 2 sizes.

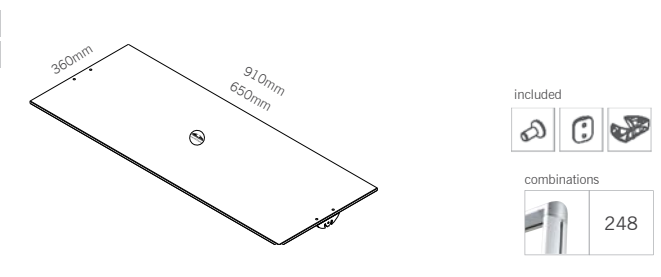

7 tray 360x200x100mm
 ripiano in acrilico satinato per il montaggio frontale sul o-profil.
ablage aus satiniertem acryl für frontale montage auf o-profil.
shelf made of satin acrylic for front mounting to o-profil.

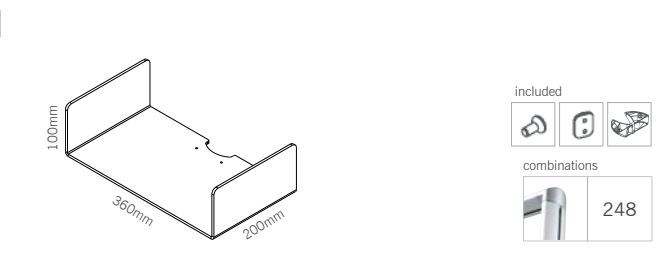

soistes® trays



8 tray A4
 ripiano in acrilico satinato per il montaggio a sospensione sui cavi di acciaio. arc, pod e cavo di acciaio da ordinare separatamente.
fachboden aus satiniertem acryl für befestigung am spannseil arc, pod und gewünschtes seil extra bestellen.
shelf made of satin acrylic for suspension. for mounting order arc, pod and wire extra.

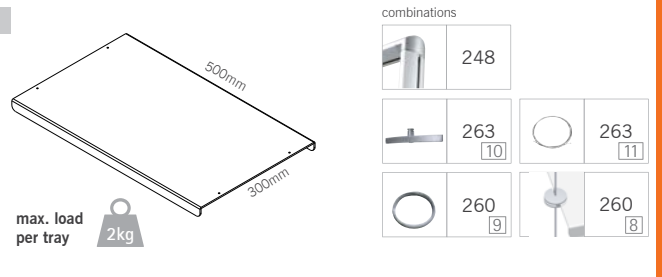

9 tray A4S
 ripiano per astine realizzato in acrilico color ghiaccio.
regalfachboden für stabsystem aus frostweissem acryl.
shelf made of frosted white acrylic, for systems on bars.

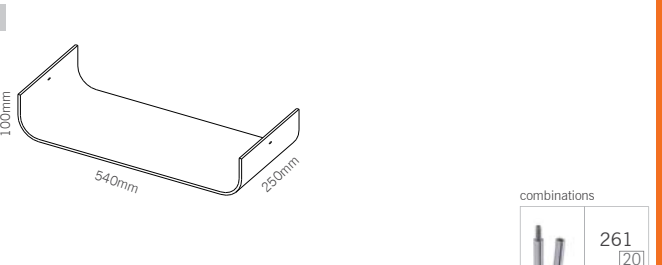

ideas

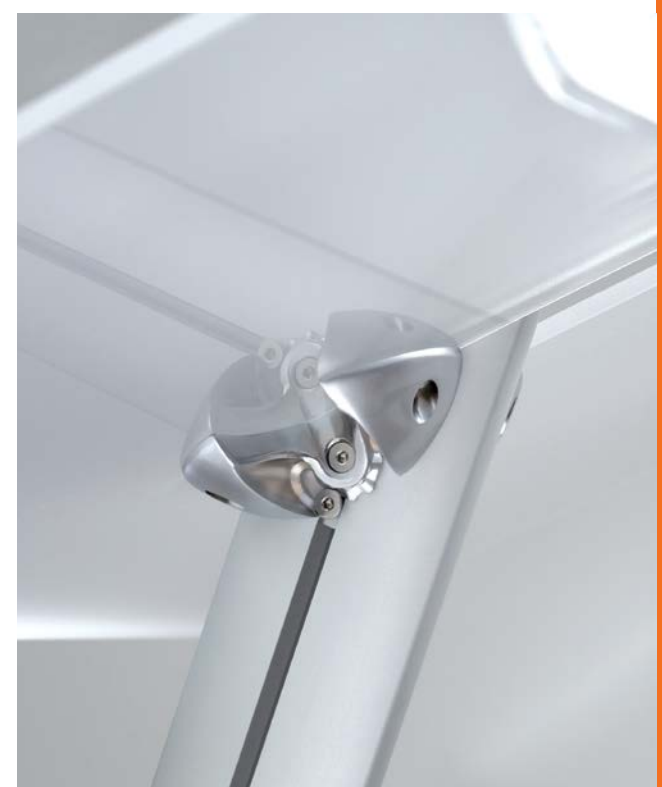
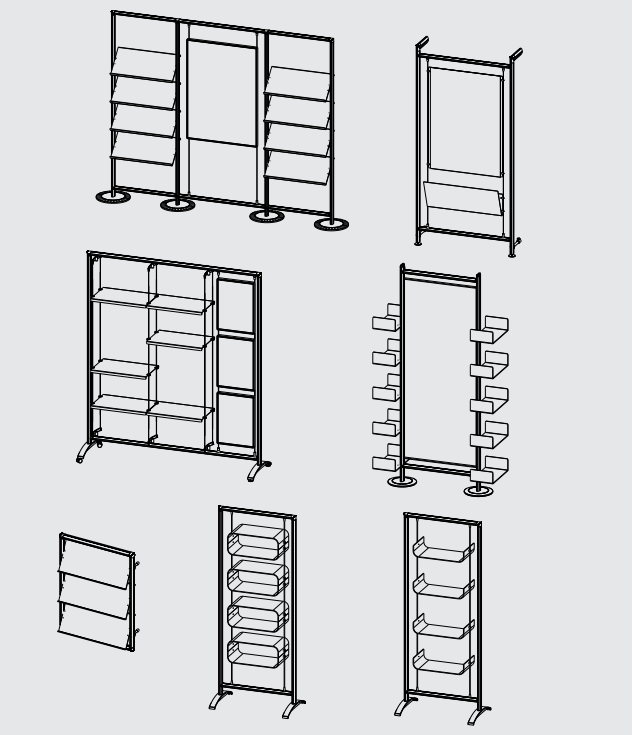

soistes trays

1	SOTRA4TR	tray A4, 1pc
2	SOTRA4STR	tray A4S, 1pc
3	SOTR2A4TR	tray2 A4, 1pc
4	SOTR650TR	tray 650, 1pc
5	SOVE650	glass 650, 1pc

6	SOVE910	glass 910, 1pc
7	SOTR360UTR	tray 360 U, 1pc
8	SOTR500TR	tray 500, 1pc
9	YAL540BC	shelf, 1pc



connector

MADE IN EU design by KD

IT sistema modulare per ripiani e scaffali; angolari in policarbonato color vetro, ripiani in acrilico trasparente. ideale per il montaggio su cavo e astine.

DE regal-baukastensystem, ecken aus glasgrünem polycarbonat, fachböden aus transparentem acryl. für stahlseil wie stangen geeignet.

EN modular system for racks, connectors made of glassgreen polycarbonate, shelves in transparent acrylic. for mounting on bars and wire.

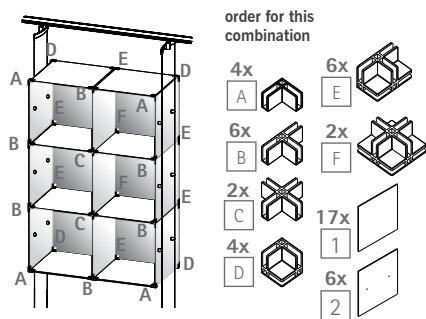
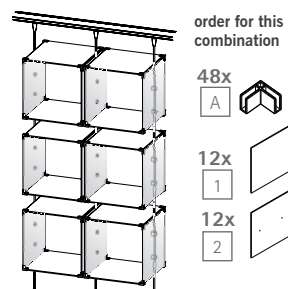

information

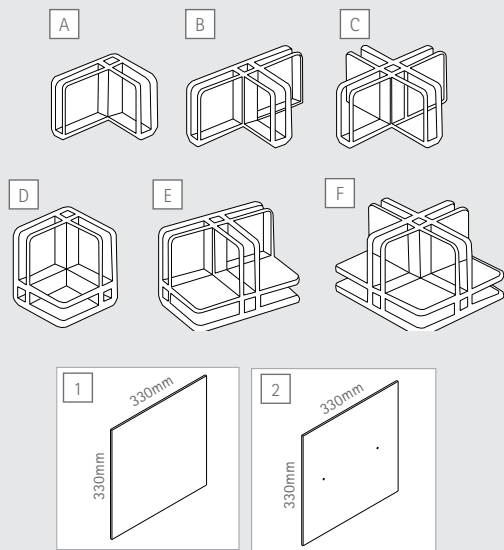

connector

max. load per tray 2kg

A	FCONA	connector A, 1pc
B	FCONB	connector B, 1pc
C	FCONC	connector C, 1pc
D	FCOND	connector D, 1pc
E	FCONE	connector E, 1pc
F	FCONF	connector F, 1pc
1	FCON330PL	shelf, 1pc
2	FCON2F330PL	shelf with holes, 1pc



information

profilo alluminio anodizzato
silber eloxiertes aluminium profil
silver anodized aluminium profile

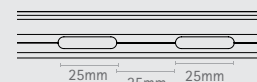

global

MADE IN EU design by KD

IT arricchite la vostra gamma di complementi per l'arredo negozi con il nuovo soistes global, il profilo per appendere accessori ed attrezzature per negozi: nelle fresature di global, infatti, trovano posto i più comuni supporti per ripiani e scaffali. global deve essere inserito nella cava del profilo prima del montaggio della struttura soistes. siamo a disposizione per soddisfare ogni vostra curiosità al riguardo.

DE erweitern sie mit dem profil global ihr soistes system für ladenbau-accessoires zum einhängen: in die fräsungen passen gängige ablagenhalter. global muss vor montage des soistes systems eingebaut werden. fragen sie uns, wir beraten sie gerne.

EN upgrade your soistes systems with the global profile for attachable shopfitting accessories: the notches are made for supports of shelves and / or trays. global must be installed before mounting the soistes system. ask us, we are happy to assist you.

global profile

1	SOGL1500	global 1500mm, 1pc
2	SOGL1700	global 1700mm, 1pc

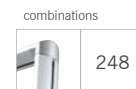

materiale plastico, colore grigio chiaro.
kunststoff, lichtgrau
gray synthetic

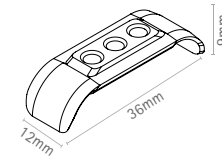

soistes nut

MADE IN EU design by KD

IT dadi per profilo soistes, utilizzabili senza dover smontare la struttura, per il montaggio di accessori leggeri.

DE nutstein für soistes profile, verwendung jederzeit ohne demontage, für montage von leichtem zubehör

EN sliding block for soistes profiles, insert anytime without disassembling, for fixing light weight accessories

soistes nut

3	SONU3612GR	soistes nut, 4pcs
---	------------	-------------------

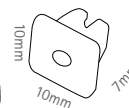

nut

IT dado ad incastro, per montare pannelli leggeri con viti autofilettanti

DE einklickmutter, für montage leichter paneele mit blechschauben

EN nut, to mount lightweight panels with self tapping screws

nut

4	SODD1010SY	nuts, box 100pcs
---	------------	------------------

soistes® accessories

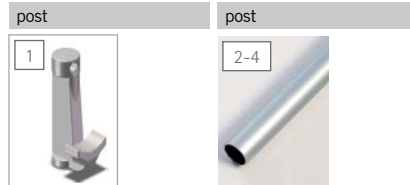

post
1
per banner con orlo: barre rod e appoggio post, alluminio anodizzato, metallo pressofuso color argento.
für banner mit saum: rod stangen und auflagenhalter post. silber eloxiertes alu und versilberter metalldruckguss
for banners with seams: rod bars and support post. silver anodised aluminium and silver-plated metal die-cast.

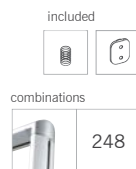
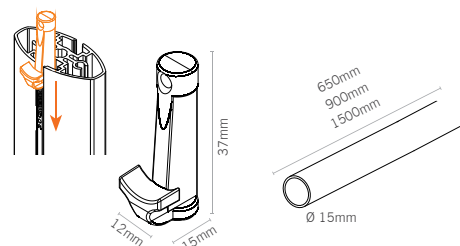

twin
5
supporto e profili a scatto banner-block per 2 banner con larghezza 400mm. unico profilo in alto, in basso in 2 pezzi.
halter und klemmprofil banner-block für 2 banner je 400mm breite. oberes profil durchgehend, unteres geteilt.
support and extrusions bannerblock for 2 banner with 400mm width. upper extrusion end to end, bottom extrusions separated.

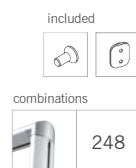
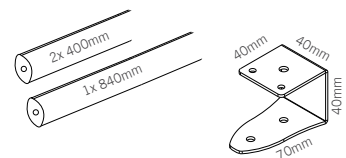

o-ring
6
per il montaggio dei banner senza occhielli.
für bannerbefestigung ohne ösen.
for banner mounting without eyelets.

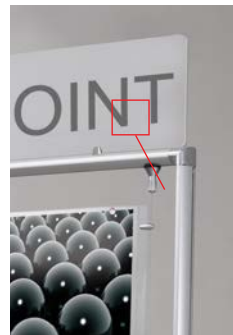
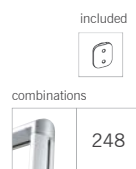
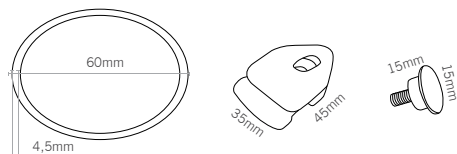

crownerfix
9
morsetto per il montaggio di crown con uno spessore massimo di 4mm, ottone color argento.
zur befestigung von topschildern mit max. 4mm stärke aus versilbertem messing.
for crowner panels mounting with max. 4mm thickness made of silver-plated brass.

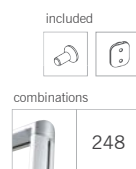
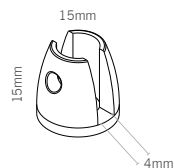

soistes accessories

1	SOPS5037	post, set 4 pcs
2	SORD650	rod 650mm, 1pc
3	SORD900	rod 900mm, 1pc
4	SORD1500	rod 1500mm, 1pc
5	SOTW400	twin 400, 1set

6	AGK60TR	silicone o-ring, box 20pcs
7	ACL3540WE	clamp, box 20pcs
8	SONB15AR	nob, box 20pcs
9	SOCF1515ARSET	crownerfix, set 2pcs



NEW PRODUCT

soistes® free pad

MADE IN EU design by KD

IT realizzate la vostra presentazione in modo multimediale: grazie ai nostri supporti freepad è possibile predisporre il vostro ipad in modo semplice all'interno della struttura soistes. sulla parte superiore, frontalmente o lateralmente, quale che sia il caso, troveremo la soluzione adatta alle sue esigenze.

DE integrieren sie die multimediale dimension in ihre präsentation: unsere free-pad-halter erlauben den einfachen einbau von ipads in ihre soistes struktur. ob on top, seitlich oder frontal - für alle varianten finden sie hier die richtige lösung.

EN bring a multi media dimension to your presentation: our free pad supports allow you to integrate easily ipads into your soistes structure. whether on top, lateral or frontal - for all versions you can find here the perfect solution.

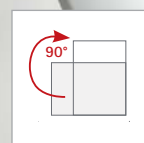

soistes free pad top
supporto ipad per profili-o soistes, alluminio anodizzato color argento e ABS color nero, inclinabile fino a 90°
ipad-halter für soistes o-profil, silber eloxiertes aluminium und schwarzer ABS-kunststoff, 90° schwenkbar.
ipad support for soistes o-profile, silver anodized aluminium and black ABS, 90° rotatable

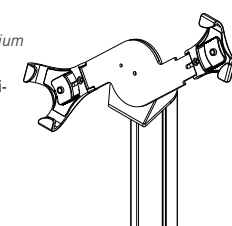

123
pad woman



soistes free pad front
supporto ipad per profilo-o soistes a montaggio frontale, alluminio anodizzato color argento in ABS nero, inclinabile fino a 90°
ipad-halter für soistes o-profil frontale montage, silber eloxiertes aluminium und schwarzer ABS-kunststoff, 90° schwenkbar.
ipad support for soistes o-profile, frontal mounting, silver anodized aluminium and black ABS, 90° rotatable

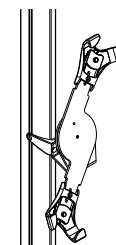

soistes free pad side
supporto ipad per profilo-o soistes a montaggio laterale, alluminio anodizzato color argento in ABS nero
ipad-halter für soistes o-profil seitliche montage, silber eloxiertes aluminium und schwarzer ABS-kunststoff, 90° schwenkbar.
ipad support for soistes o-profile, lateral mounting, silver anodized aluminium and black ABS, 90° rotatable

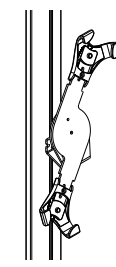

soistes free pad

1	SOFPTOP	soistes free pad top, 1pc
2	SOFFFRONT	soistes free pad front, 1pc
3	SOFFSIDE	soistes free pad side, 1pc

pole soistes

MADE IN EU design by KD

IT grazie al sistema di appoggio libero pole soistes, si possono ora realizzare strutture e moduli soistes tra parete e soffitto e senza dover praticare fori. ad ogni estremità possono essere livellati 25mm. offriamo pole soistes in diverse lunghezze standard.

DE mit dem freistehenden spannelement pole soistes lassen sich soistes module einfach ohne bohrungen zwischen wand und decke realisieren. jeweils 25mm können an jedem ende ausgeglichen werden. wir bieten ihnen den soistes pole in diversen standardlängen an.

EN with the freestanding clamping element pole soistes you can build soistes structures between floors and ceilings easily without having to drill holes. each end can be adjusted max. 25mm. we offer you pole soistes in different standard lengths.



pole soistes		
1	SOPE2000	soistes pole, 1pc
2	SOPE2500	soistes pole, 1pc
3	SOPE3000	soistes pole, 1pc



ideas

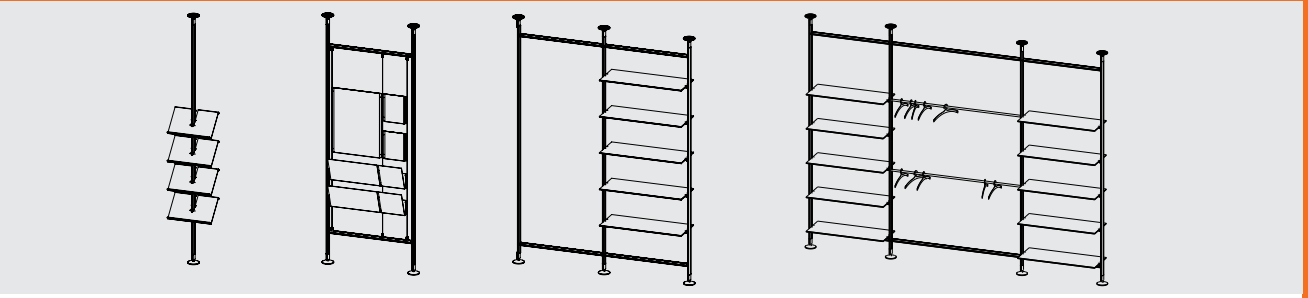

information

metallo pressofuso color argento opaco, profilo di aggancio in alluminio anodizzato.
 silber matt verchromter metall-druckguss, silber eloxierte alu-miniumprofile
 silver matt plated die cast metal, silver anodized aluminium profiles

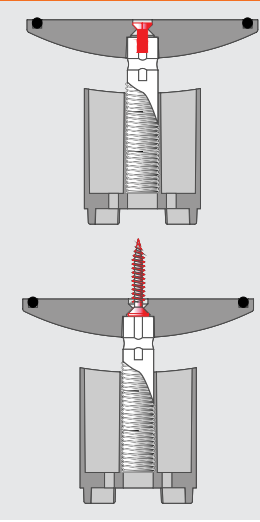
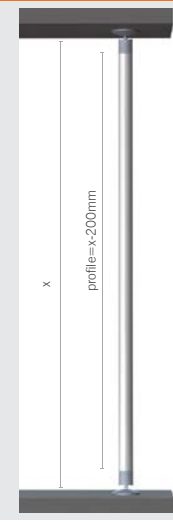
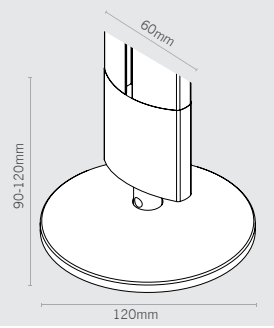

soistes® accessories

1 **soistes fix**
tirante per cavi, ottone color argento
seilhalter mit schraubhülse, messing versilbert
cable support with screw sleeve, silver-plated brass

7 **beak**
pinza con filetto per cavi, ottone color argento
paneelhalter mit gewinde für seil, messing versilbert
panel support with thread for cable, silver-plated brass

2 **tengo**
pinza laterale per cavi, ottone color argento
paneelhalter für seil, messing versilbert
panel support for cable, silver-plated brass

8 **pod**
supporto per ripiani su cavi, ottone color argento
fachbodenhalter für seil, messing versilbert
shelf support for cable, silver-plated brass

3 **hold**
pinza laterale regolabile per cavi, ottone color argento
paneelhalter regulierbar für seil, messing versilbert
flexible panel support for cable, silver-plated brass

9 **afil**
cavo di acciaio rivestito in pvc
stahlseil mit pvc beschichtung
steel wire pvc coated

4 **coppia**
pinza laterale doppia per cavi, ottone color argento
doppel-paneelhalter für seil, messing versilbert
double panel support for cable, silver-plated brass

10 **ideas**

5 **brace**
pinza laterale doppia regolabile, ottone color argento
doppel-paneelhalter für seil regulierbar, messing versilbert
flexible double panel support for cable, silver-plated brass

6 **front**
morsetto regolabile, montaggio frontale su cavi, ott. col. argento
paneelhalter regulierbar, frontmontage, messing versilbert
flexible panel support front mounting, silver-plated brass

soistes accessories

1	SOFX3035ARSET	soistes fix, set 2pcs
2	YTG1329ARSET	tengo, set 4pcs
3	YHO1329ARSET	hold, set 4pcs
4	YCO1340ARSET	coppia, set 4pcs
5	YBR1340ARSET	brace, set 4pcs

6	YFR1315ARSET	front, set 4pcs
7	YBK1320ARSET	beak, set 4pcs
8	SOP030ARSET	pod, set 4pcs
9	AFILO5	afil, 5m
10	AFIL25	afil, 25m

soistes® accessories

11 **soistes forte**
tirante per astine, ottone color cromo lucido
halter für stange, messing verchromt
ceiling support for bars, chrome-plated brass

12 **soistes spina**
tirante a terra per astine, ottone color cromo lucido
bodenhalter für stange, messing verchromt
floor support for bars, chrome-plated brass

13 **profi**
morsetto frontale per 2 pannelli su astine, ottone cromo
doppel-paneelhalter für stange, messing verchromt
front double panel support for bars, brass chrome-plated

14 **maestro**
morsetto frontale per pannelli su astine, ottone cromo
paneelhalter für stange, messing verchromt
front panel support for bars, brass chrome-plated

15 **mira**
pinza laterale per pannelli su astine, ottone cromo
seitlicher paneelhalter für stange, messing verchromt
lateral panel support for bars, brass chrome-plated

soistes accessories

11	SOF01529CMSET	soistes forte, set 2pcs
12	SOSP1543CMSET	soistes spina, set 4pcs
13	YCS1527CMSET	profi, set 4pcs
14	YWS1525CMSET	maestro, set 4pcs
15	YMI1536CMSET	mira, set 4pcs
16	YWS1545CMSET	lato, set 4pcs
17	YDP1538CMSET	doppio, set 2pcs

16 **lato**
pinza laterale regol. per pannelli su astine, ottone cromo
seitlicher paneelhalter für stange, messing verchromt
lateral panel support for bars, brass chrome-plated

17 **doppio**
pinza laterale doppia per pannelli su astine, ottone cromo
seitlicher doppel-paneelhalter für stange, messing verchromt
double lateral panel support for bars, brass chrome-plated

18 **cupido**
pinza laterale doppia regol. per pannelli su astine, ottone cromo
seitlicher doppel-paneelhalter für stange, messing verchromt
double lateral panel support for bars, brass chrome-plated

19 **amo**
pinza regol. per pannelli su astine, ottone color cromo
paneelhalter für stange, messing verchromt
panel support for bars, brass chrome-plated

20-23 **asta**
astine modulari, ottone cromato
modulare stangen mit gewinde, messing verchromt
modular bars with threads, croma brass

18	YWS1568CMSET	cupido, set 2pcs
19	YCS1535CMSET	amo, set 2pcs
20	YWS3006CM	asta 300mm, set 2pcs
21	YWS4006CM	asta 400mm, set 2pcs
22	YWS8006CM	asta 800mm, set 2pcs
23	YWS10006CM	asta 1000mm, set 2pcs

soistes® accessories



flybag
tasca portaprospekti realizzata in acrilico color trasparente.
prospekttasche, transparentes acrylglas
brochure tray made of transparent acrylic.

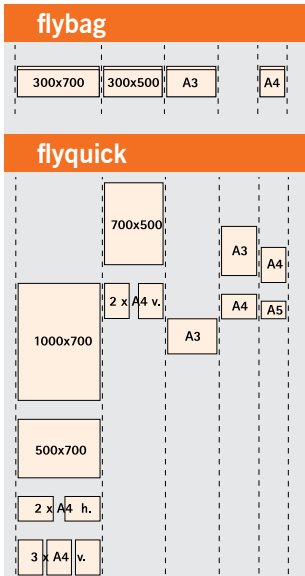

flyquick
tasche per informazioni con chiusura a calamita realizzate in acrilico color trasparente
info-tasche mit magnetverschluss aus transparentem acryl
poster pocket with magnetic lock made of transparent acrylic.



magnedoor
cornice velocemente intercambiabile con chiusura magnetica resistente all'acqua. ordinare separatamente i supporti wire o dot per il montaggio
schnellwechselrahmen mit wasserabweisendem mag-netverschluss. befestigung wire oder dot extra bestellen.
quick exchange frame with water resistant magnetic lock. order extra support wire or dot for mounting.

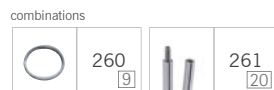
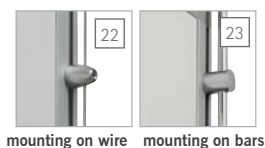

soistes accessories

1	YBPA4	flybag A4, 1pc
2	YBPA3	flybag A3, 1pc
3	YBP500	flybag 300x500mm, 1pc
4	YBP700	flybag 300x700mm, 1pc
5	YQP1A5H	flyquick A5 horizontal, 1pc
6	YQP1A4H	flyquick A4 horizontal, 1pc
7	YQP1A4V	flyquick A4 vertical, 1pc
8	YQP2A4H	flyquick 2xA4 horizontal, 1pc
9	YQP2A4V	flyquick 2xA4 vertical, 1pc
10	YQP3A4V	flyquick 3xA4vertical, 1pc
11	YQP1A3V	flyquick A3 vertical, 1pc
12	YQP1A3H	flyquick A3 horizontal, 1pc

13	YQP500700	flyquick 500x700mm, 1pc
14	YQP700500	flyquick 700x500mm, 1pc
15	YQP7001000	flyquick 700x1000mm, 1pc
16	YQP1000700	flyquick 1000x700mm, 1pc
17	MADA4	magnedoor A4, 1pc
18	MADA3	magnedoor A3, 1pc
19	MADA1	magnedoor A1, 1pc
20	MAD700500	magnedoor 700x500mm, 1pc
21	MAD1000700	magnedoor 1000x700mm, 1pc
22	YWI1325ARSET	wire silver set, 4pcs
23	YDO1525CMSET	dot chrome set, 4pcs

soistes® accessories



clipper
cornice a scatto, ordinare separatamente i supporti wire o dot per il montaggio
schnellwechselrahmen, befestigung wire oder dot extra bestellen.
quick exchange frame. order extra support wire or dot for mounting.

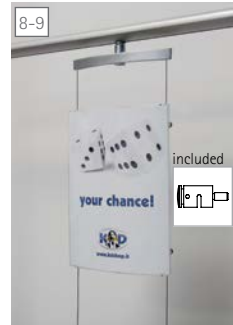
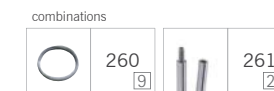

pixquick
tasca porta informazioni realizzata in policarbonato stampato ad iniezione. supporti per il montaggio a cavo inclusi.
info-präsentier aus polycarbonat-spritzguss, schnell und einfach zu wechseln. befestigung für seilspannsystem inklusive.
information display made of polycarbonate die-cast, quick and easy exchange. mounting supports for wire suspension included.



arc
supporto per cavi di acciaio (mass. ø1,7mm) e flystyle asta, metallo a pressofusione color argento
befestigung für stahlseil (max. ø1,7mm) und flystyle asta, versilberter metall-druckguss
mounting support for steel wire (max. ø1,7mm) and flystyle asta. silver-plated metal die-cast.

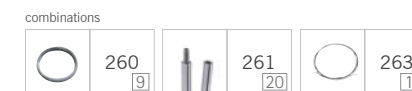
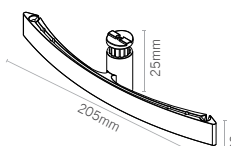

filo
cavo in acciaio inox con sfera presso fusa.
edelstahlseil mit druckgussnippel.
stainless steel wire with fitting.

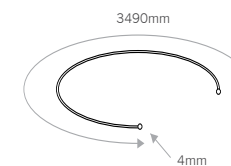

soistes accessories

1	YCLA4	clipper A4, 1pc
2	YCLA3	clipper A3, 1pc
3	YCLA1	clipper A1, 1pc
4	YCL700500	clipper 700x500mm, 1pc
5	YCL1000700	clipper 1000x700mm, 1pc
6	YWI1325ARSET	wire silver set 4pcs

7	YDO1525CMSET	dot chrome set 4pcs
8	PQCA4	pixquick for cable A4, 1pc
9	PQCA5	pixquick for cable A5, 1pc
10	SOAC250AR	arc, set 2pcs
11	SOFI3490	filo 3490mm, 1pc



1
cart 900

cart soistes

MADE IN EU design by KD

IT cart è la struttura base mobile per la vostra presentazione su cavi o astine. profili in alluminio anodizzato color argento, piedini di metallo in pressofusione, color argento e 4 ruote stabili.

DE cart ist die mobile basis struktur für ihre präsentation am spannsel oder an der stange. silber eloxierter aluminiumprofilrahmen, füsse aus versilbertem metalldruckguss und 4 stabile leichtlaufrollen.

EN cart is the mobile base structure for your wire suspension presentations. silver anodised aluminium extrusions, feet made of silver-plated die-cast metal with 4 stable and smooth rolling wheels.

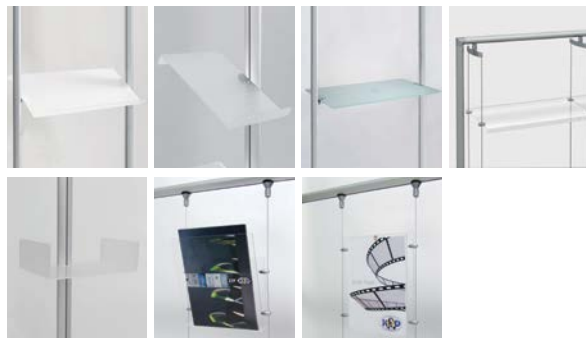

ulteriori informazioni pag.
mehr details s.
more information p.

252

information

profili in alluminio anodizzato, piedini di metallo in pressofusione, munito di 4 stabili ruote.

silber eloxiertes alu-profil, versilberter metalldruckguss, stabile rollen

silver anodised aluminium profile, silver-plated metal die-cast, stable casters

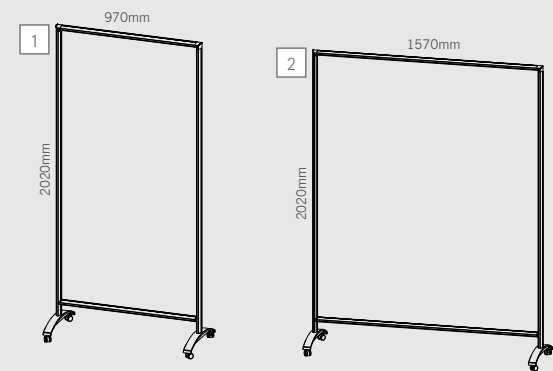

cart soistes

1	SOCA900	cart 900mm, 1pc	
2	SOCA1500	cart 1500mm, 1pc	



1 + 2
cart 900 + cage

cage soistes

MADE IN EU design by KD

IT grata di colore grigio argentato verniciata a polveri, realizzata con fil di ferro del diametro di 4mm, dimensioni 46 mm circa. ideale per l'utilizzo su strutture fisse o mobili. per presentazioni, tra le altre cose, di tessuti, quadri o altri accessori.

DE silbergrau pulverlackbeschichtetes gitter-paneel aus ø4mm starkem draht mit gittergröße ca. 46mm. zum einbau in mobile wie festmontierte strukturen. für präsentation z.b. von textilien, bildern oder anderen accessoires.

EN silver-grey powder coated grid panel made of ø4mm strong wire mesh (46 x 46mm). grid panel can be used with the mobile carts and as well with mounted structures. for presentations of, for example, textiles, pictures or other accessories.

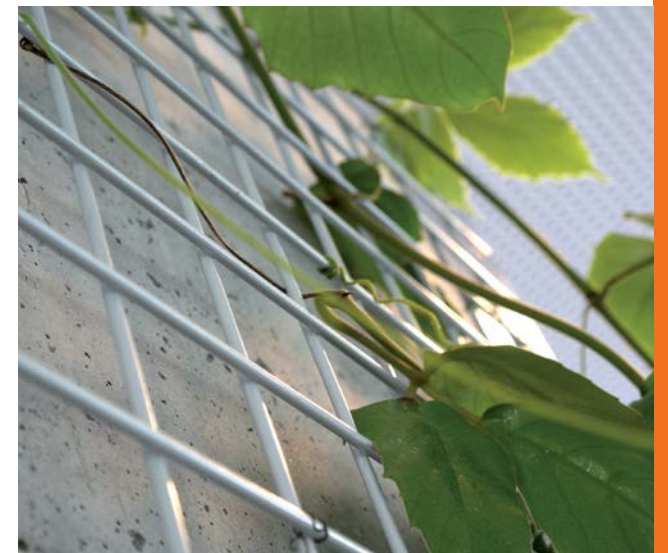

information

profili in alluminio anodizzato, piedini di metallo in pressofusione, munito di 4 stabili ruote.

silber eloxiertes alu-profil, versilberter metalldruckguss, stabile rollen.

silver anodised aluminium profile, silver-plated metal die-cast, stable casters

grata di colore grigio argentato verniciata a polveri, realizzata con fil di ferro del diametro di 4mm, dimensioni 46mm circa.

silbergrau pulverlackbeschichtetes gitter-paneel aus ø4mm starkem draht mit gittergröße ca. 46mm.

silver-grey powder coated grid panel made of ø4mm strong wire mesh (46 x 46mm).

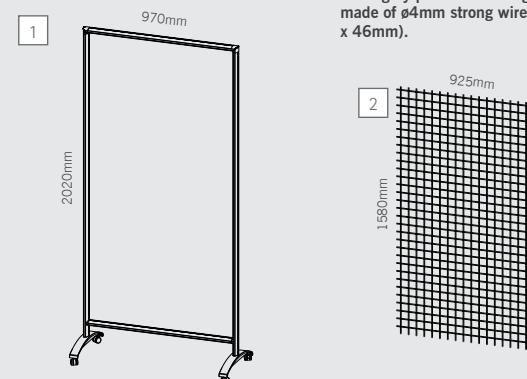

cage soistes

1	SOCA900	cart 900mm, 1pc	
2	SOCG9251580	cage 1580x925mm, 1pc	

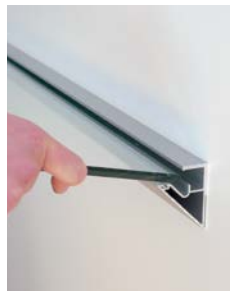
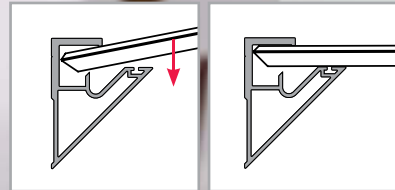

montaggio semplice e senza utensili: il peso stesso e il listello di pvc all'interno del profilo mantengono i ripiani stabilmente in posizione.

einfach einhängen ohne werkzeug: eigengewicht und innenliegende pvc-schutzlätze halten fachböden in position.

easily attached without any tools: the shelf's own weight and pvc protection lace keeps them in a stable position



profilo in alluminio anodizzato color argento, materiale per il montaggio incluso

silber eloxiertes aluminium profil, inkl. montage-material

silver anodized aluminium profile, incl. mounting material



vetro temperato di sicurezza, con angoli molati, logo in serigrafia

temperiertes sicherheitsglas mit facettenschliff, siebdruck logo

tempered glass with faceted edges, silk screen printed brand

information

il nostro consiglio: provate ripiano anche in combinazione con scaffali in altri materiali come legno o pietra.

unser tip: probieren sie ripiano in gleicher abmessung aber mit anderen materialien wie holz oder stein.

our tip: try ripiano in same size but with other materials such as wood or stone.

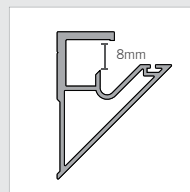

ripiano

MADE IN EU design by KD

IT design nobile adatto a qualsiasi tipo di arredamento per negozi, uffici, hotel o per casa: montare a parete il binario e agganciare semplicemente il ripiano in vetro. la particolare sfaccettatura degli angoli molati crea bellissimi effetti di luce. anche in combinazione con scaffali di altri materiali, ripiano è semplicemente splendido.

DE edles design für jede einrichtung ob shop, office, hotel oder home: ripiano rail wandmontieren und die glasfachböden einfach eingehängen. der besondere kantenschliff schafft brillante lichteffekte. aber auch mit ablagen aus anderen materialien sieht ripiano einfach toll aus.

EN noble design for every ambience in shops, offices, hotels or homes: wall mount the ripiano rail and simply attach the tempered glass shelves. the special design of the glass edges creates brilliant light effects. also with shelves in other materials ripiano is a real looker.

ripiano

1	RIR400AL	rail 400mm, 1pc
2	RIR600AL	rail 600mm, 1pc
3	RIR900AL	rail 900mm, 1pc
4	RIV400240	glass 400x240mm, 1pc
5	RIV600240	glass 600x240mm, 1pc
6	RIV600320	glass 600x320mm, 1pc
7	RIV900240	glass 900x240mm, 1pc
8	RIV900320	glass 900x320mm, 1pc



information



sarto soistes

MADE IN EU design by KD

IT espositore mobile per i vestiti oppure ideale come guardaroba nel backstage: ecco il vostro sarto soistes. i profili in alluminio anodizzato color argento su ruote e un ripiano, realizzato in vetro temperato, rendono questo display un espositore esclusivo e sempre alla moda.

DE mobiler präsenler für kleidung oder auch garderobe im backstage-bereich ist ihr sarto soistes. silber eloxierte aluminiumprofile auf leichtlaufrollen inklusive einer ablage aus temperiertem glas machen dieses display zu einem exklusiven mode-präsenler.

EN mobile display for clothes or even as a back stage wardrobe: that's your soistes.the profiles, in silver anodised aluminium on wheels with a shelf, made of tempered glass, makes this an exclusive and fashionable display.

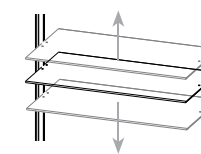

sarto soistes

1 SOSA650VE sarto soistes, 1pc



information



store soistes

MADE IN EU design by KD

IT store soistes è la libreria mobile, robusta e resistente. i profili in alluminio anodizzato, color argento e i 3 ripiani di vetro temperato, si reggono su piedini di gomma rigida. ogni ripiano si può disporre a libera scelta lungo tutta la lunghezza del profilo.

DE ganz robust und belastbar ist store das mobile regal. silber eloxierte aluminiumprofile und drei temperierte glasfachböden stehen sicher auf hartgummifüssen. jede ablage ist stufenlos höhenverstellbar.

EN extremely robust, that's store the mobile rack. silver anodised aluminium and three shelves made of tempered glass on hard rubber feet. every shelf is adjustable in height.

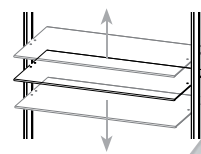

store soistes

2 SOST650VE store soistes, 1pc

**NEW
PRODUCT**



framframe silentART

MADE IN EU design by KD



profili in alluminio anodizzato color argento, angoli in metallo pressofuso color argento opaco, nucleo fonoassorbente
silber eloxiertes aluminium, silbermatt verchromte eckverbinder aus metall-druckguss, schallschluckender kern
silver anodized aluminium, silver matt plated corner connectors made of metal die-cast sound absorbing core



free standing
base di appoggio in metallo verniciato color argento
bodenplatte aus silberlackiertem metall
floor plate made of silver varnished metal



on the wall
per il fissaggio a parete agganciare nella apposita sede
zur wandbefestigung in die nut einhängen
attach to the notch for wall mounting

IT una decorazione per interni con un nucleo intelligente: dietro il tessuto stampato in digitale troverete materiale isolante fonoassorbente. potrete usare i prodotti silentART come pareti divisorie flessibili, decorazioni di tendenza a parete o a sospensione. il banner in tessuto può essere cambiato facilmente in modo da rendere sempre attuale questo prodotto per l'insonorizzazione degli spazi. silentART: più benessere nel vostro ambiente.

DE coole dekoration mit intelligentem kern: hinter dem bedruckten stoff steckt eine schall-absorbierende isolierung. sie können silentART produkte als flexible raumtrenner, dekorative wandgestaltung oder trendige deckenabhängung verwenden. der stoff lässt sich leicht austauschen, so bleibt dieser lärmschutz immer aktuell und wird nie langweilig. silentART: die intelligente lösung für mehr wohlfinden im raum.

EN a cool interior with an intelligent core: behind the digital printed textile there is noise absorbing isolating material. you can use the silentART products as flexible partition, decorative wall design or trendy ceiling suspension. the textile banner can be exchanged easily. this is a noise reducing product with an always up-to-date style. silentART: more wellness in your rooms.

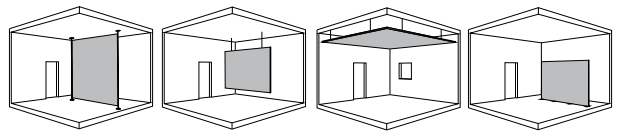

ulteriori informazioni pag. 146
mehr details s. more information p. 146



5 + 6
silentART 1900x1260mm + framframe base

information

frame length = profile + 60mm

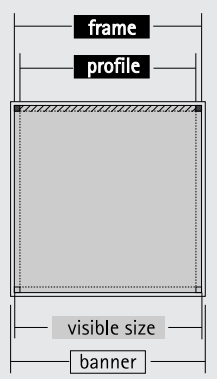

banner = visible size + 20mm

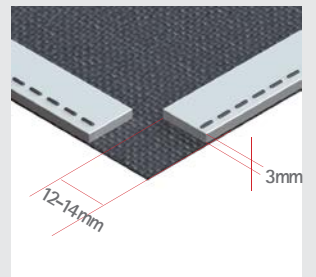

inserire il banner di tessuto con le strisce di silicone partendo dagli angoli.
stoffbanner mit silikonlippe von den ecken ansetzend frontal einsetzen.
textile banners are mounted easily with silicone seam starting from the edges

framframe silentART

1	FFSI660660	silentART 660x660mm, 1pc
2	FFSI1260660	silentART 1260x660mm, 1pc
3	FFSI12601260	silentART 1260x1260mm, 1pc
4	FFSI1900660	silentART 1900x660mm, 1pc
5	FFSI19001260	silentART 1900x1260mm, 1pc
6	FFRB300100	framframe base, 2pcs

vetrina top

MADE IN EU controlled by KD

IT vetrinetta illuminata rifinita al top: tutti i ripiani sono regolabili sia in altezza che per inclinazione. i 2 spot alogeni illuminano perfettamente gli oggetti esposti su ogni ripiano. il vetro temperato e il fondo a specchio forniscono luminosa trasparenza e un tocco di eleganza in più. il pannello di copertura e quello di fondo sono in rovere schiarito.

DE vitrine in topausführung mit beleuchtung: alle fachböden können sowohl in höhe wie auch neigung individuell eingestellt werden. 2 halogen-spots je ablage leuchten jedes objekt optimal aus. temperiertes glas und bodenspiegel garantieren transparente optik und elegantes flair. boden- und deckenplatte aus mdf mit eiche gebleicht laminat.

EN high quality glass display case with lighting: all shelves can be regulated in height or inclined individually. 2 halogen spot lights per shelf illuminate perfectly all objects on display. tempered glass and the mirror on the bottom guarantee a transparent look and elegant flair. top and bottom panel made of mdf with white oak laminate.



lampade alogene a basso voltaggio orientabili.

verstellbare niedervolt halogen leuchten.

adjustable halogen spot lamps.



antina protetta con serratura.

flügel-türe mit schloss gesichert.

doors equipped with lock.



montata su rotelle per una maggiore mobilità.

rollen für flexiblen einsatz.

mobile thanks to the wheels.

information

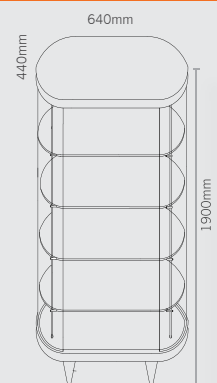

vetrina top

1 VTT6444RSB *) sample monsterframe, 1pc



*) merce voluminosa: l'indirizzo di consegna deve essere facilmente raggiungibile con grandi mezzi di trasporto. ritiro con vs corriere e/o spedizione assieme ad altra merce non possibile.
 *) sperrgut: zustellungsort muss für lkw erreichbar sein, keine selbstabholung, kein versand mit anderen waren
 *) bulk goods: delivery address must be accessible to large trucks, no ex works collections possible, no shipping along with other goods

vetrina

MADE IN EU controlled by KD

IT vetrinetta rettangolare con illuminazione interna realizzata con vetro temperato, MDF verniciato argento, robuste rotelle e 4 ripiani: ideale per presentazioni in showroom, negozi o uffici, ma anche per fiere ed altri eventi in cui esporre oggetti in una cornice particolarmente avvincente.

DE rechteckige vitrine mit deckenleuchten: temperiertes glas, silberlackiertes MDF und stabile rollen zeichnen diese vitrinen aus. 4 fachböden zur präsentation in showroom, shop und office. auch auf messen und anderen events oder ausstellungen ein besonderer rahmen für ihre präsentation.

EN square glass case with ceiling lighting: tempered glass, silver laminated mdf and stable wheels characterize these show cases. 4 shelves for presentation in showrooms, shops and offices. also for fairs, events and other exhibitions, a unique display for your presentation.



protetta da apposita serratura.

mit türschloss gegen unbefugtes öffnen gesichert.

no unauthorized access thanks to the integrated locks.



montata su rotelle per una maggiore mobilità.

rollen für flexiblen einsatz.

mobile thanks to the wheels.

information

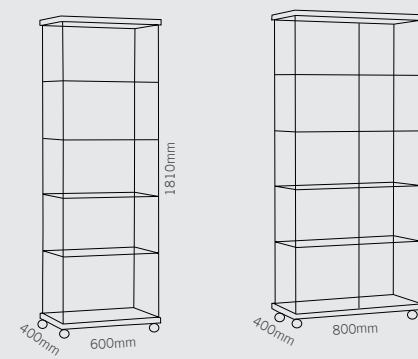

vetrina top

1 VTR6040AR *) vetrina small 1pc
 2 VTR8040AR *) vetrina big 1pc

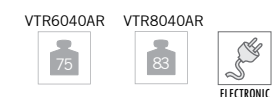

*) merce voluminosa: l'indirizzo di consegna deve essere facilmente raggiungibile con grandi mezzi di trasporto. ritiro con vs corriere e/o spedizione assieme ad altra merce non possibile.
 *) sperrgut: zustellungsort muss für lkw erreichbar sein, keine selbstabholung, kein versand mit anderen waren
 *) bulk goods: delivery address must be accessible to large trucks, no ex works collections possible, no shipping along with other goods

connector

MADE IN TAIWAN quality control by KD

IT sistema modulare per vetrine ad incastro. realizzate la vostra personalissima vetrina con pannelli da 5mm ed i fissaggi angolari connector in policarbonato color vetro. a seconda della forma e delle dimensioni della vostra applicazione, ordinate i singoli pezzi che vi servono. gli esempi qui riproposti vi aiutano nella scelta del fissaggio giusto. ideale per negozi, showroom, musei, vetrine e anche per l'arredamento di casa.

DE schlagfeste eckverbinder aus glasgrünem polycarbonat für cuben nach dem baukasten-system. gestalten sie ihre persönliche vitrine mit connector eckhaltern und 5mm-paneelen. die beispelskizzen helfen Ihnen bei der richtigen auswahl der entsprechenden eckverbinder. eine tolle sache für shop, showroom, museum, schaufenster und homebereich.

EN shock-resistant panel-connector made of glassgreen polycarbonate for modular cube systems. create your personal vitrine with 5mm-panels and connectors. the drawings with examples help you choosing the right parts. it's a peach for shop, showroom, museum, shop window and home as well.

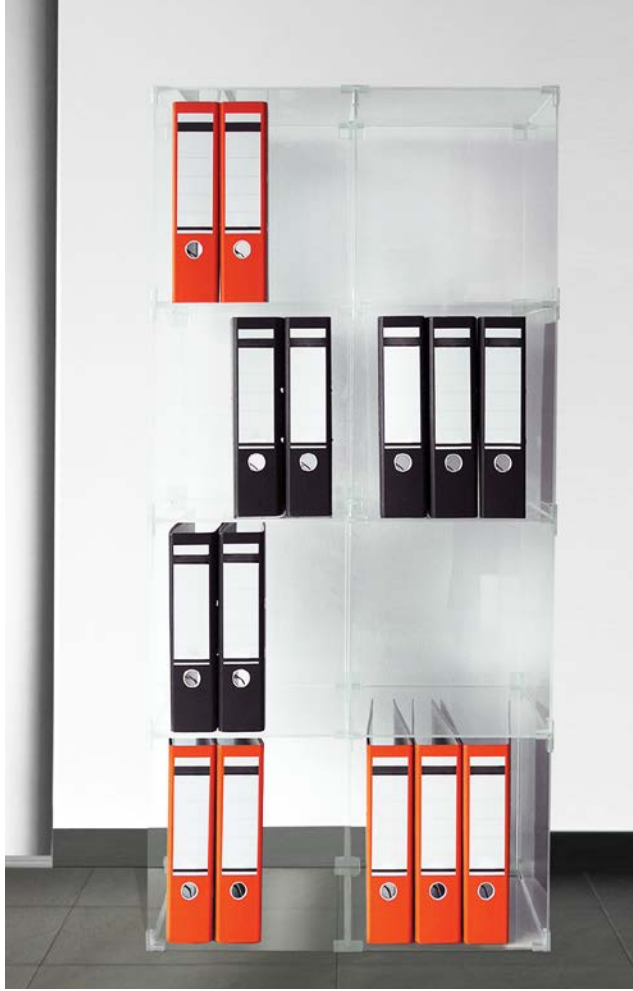

C
FCONC

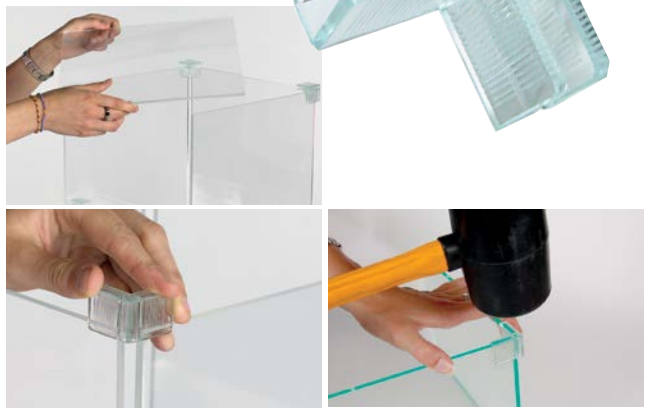

information

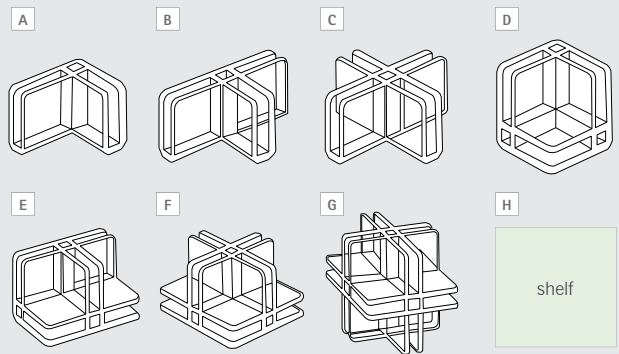

connector



A	FCONA	1pc
B	FCONB	1pc
C	FCONC	1pc
D	FCOND	1pc
E	FCONE	1pc
F	FCONF	1pc
G	FCONG	1pc
H	FCON330PL	shelf, transparent acrylic, 330x330x5mm, 1 pc

space

MADE IN EU design by KD

IT space lampada gonfiabile realizzata con uno speciale telo superfine. grazie ad un ventilatore invisibile, space si gonfia e viene tenuta in piedi dall'aria.

DE space aufblasbare leuchte in federleichtem spezialstoff. dank des eingebauten ventilators wird space mit luft gefüllt und in form gehalten.

EN space inflatable lamp made of extra-thin airproof fabric. thanks to an invisible ventilator space inflates and stays vertical.



4
space



regolatore d'intensità: per un'illuminazione soffusa o più vivace.
dimmer für stufenlose regelung des lichts: von sanft bis hell.
dimmer infinitely variable for softer or brighter lighting.

information



your own print!

2100mm
300mm

space



1	SP2150300BL		space blue, 1pc
2	SP2150300RE		space red, 1pc
3	SP2150300GR *		space green, 1pc
4	SP2150300WH		space white, 1pc
5	SP2150300YE		space florescent yellow, 1pc
6	SP2150300OR		space florescent orange, 1pc

* fino ad esaurimento scorte | solange vorrat reicht | while stock last

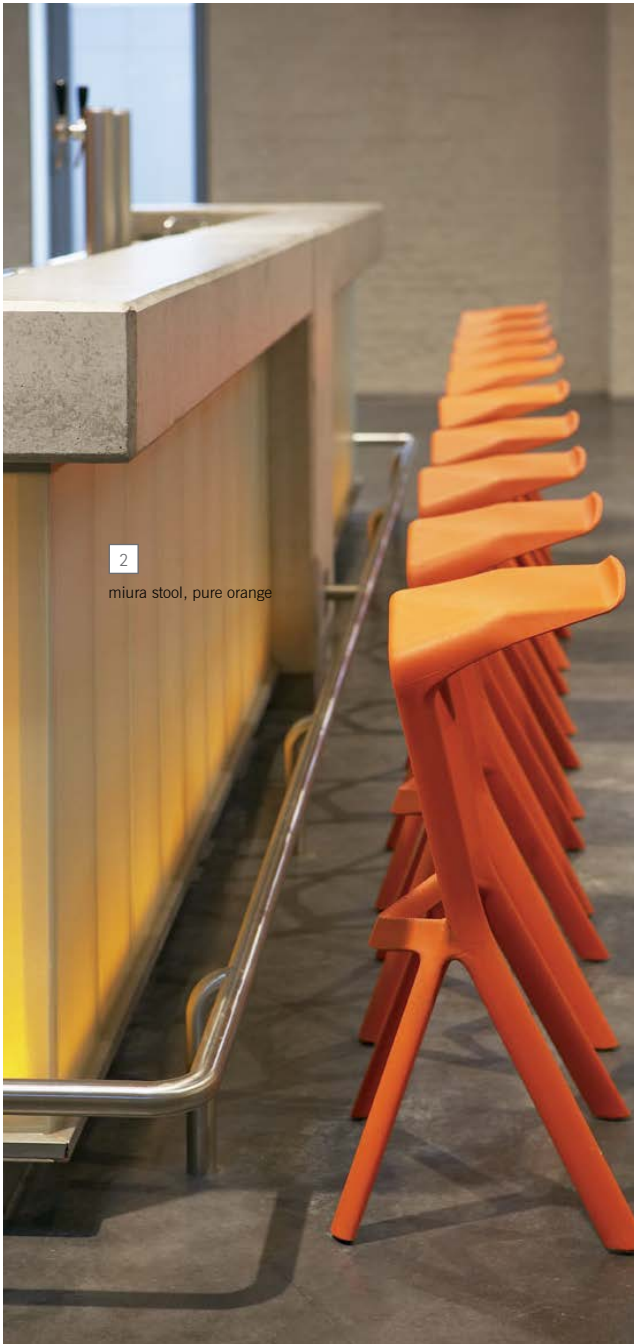

2
miura stool, pure orange

miura stool & table

design by konstantin grcic, produced by plank winner 100% design blueprint best product award 2005

IT design vincente di konstantin grcic. sgabello impilabile in polipropilene rinforzato. in linea con il sgabello miura il tavolo ha una struttura a tre gambe in acciaio zincato verniciato a polvere. sgabelli impilabili e tavolini pieghevoli per meno ingombro sia per il trasporto che per lo stoccaggio. entrambi adatti per uso interno ed esterno.



DE gewinnendes design von konstantin grcic: stapelbarer barhocker aus verstärktem polypropylen. passend dazu der miura table: dreibeiniges tischgestell aus verzinktem, pulverbeschichtetem stahl. stapelbar und volumensparend bei transport und lagerung. beide produkte für innen- wie aussenbereich.

EN winning design by designer konstantin grcic: stackable stool in reinforced polypropylene. in line with miura stool is the miura table made of varnished galvanized steel. thanks to the locking system the table is foldable and saves space during transport and storage as well. both items are for in- and outdoor.



miura stool

1	MIURA1027	curry yellow, 1pc
2	MIURA2004	pure orange, 1pc
3	MIURA3020	signal red, 1pc
4	MIURA3009	oxide red, 1pc
5	MIURA9002	white grey, 1pc
6	MIURA5013	cobalt blue, 1pc
7	MIURA7021	black, 1pc

miura table

8	TMIURA3020L	signal red, 1pc
9	TMIURA9002L	grey white, 1pc
10	TMIURA7021L	black grey, 1pc

information

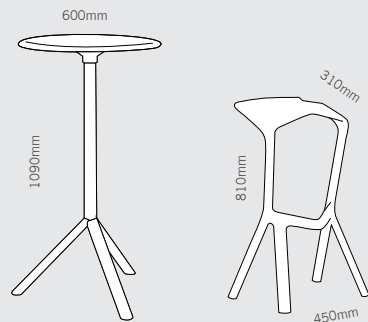

rondo

MADE IN EU design by KD

IT grazie a rondo, dalla serie stopper, potete arredare i vostri ambienti con tavolini e punti di appoggio eleganti e funzionali. base con rivestimento di protezione in abs cromato; tavolini disponibili in vetro e in mdf verniciato color argento: usati in combinazione l'uno con l'altro, i due tavolini vi danno la possibilità di sfruttare una superficie personalizzabile. in aggiunta, potete rendere personalizzabile anche la base, grazie all'insero centrale in vetro da usare in combinazione con il rivestimento laterale di protezione. rondo è semplicissimo da montare, rendendosi così insostituibile per fiere, eventi, negozi, showroom e uffici.

DE mit den rondo tischen aus dem stopper programm mehrwert sichern: basis mit mattverchromtem trittschutzring aus abs. die tischplatten sind in glas oder silberlackiertem mdf erhältlich. in der kombination beider ausführungen miteinander erhalten sie eine schnell personalisierbare werbefläche. dazu passt die ebenfalls schnell mit printinlay gestaltete basis mit glaseinsatz. rondo ist schnell aufgestellt und empfiehlt sich für messen, events, shop, showroom und office.

EN gain publicity space with the rondo tables: base with a satin chrome-plated step-on protection made of abs. the table tops are available in glass or silver-varnished mdf. with the combination of both table tops you get a quick customizable extra marketing space. in this version the base can also be customized with a print inlay in no time at all. rondo sets up quickly and is your perfect choice for fairs, events, shops, offices and showrooms.



1
rondo
ulteriori informazioni pag. 238
mehr details s. 238
more information p. 238

rondo

1 STCRONDOMDF * set rondo table top mdf, 1pc

* fino ad esaurimento scorte | solange vorrat reicht | while stock last

ping meets pong

MADE IN EU design by walking chair, vienna

IT tavolo da gioco, da pranzo e da lavoro tutto in uno? tutto ciò è reso possibile dalla sfera al centro del tavolo, di 2 m di diametro, dove si inseriscono la rete mobile o il tavolino girevole. ping meets pong è disponibile in blu e in nero, il tavolino centrale è bianco. la superficie del tavolo è ricoperta da uno strato di melanina, la struttura è in acciaio laccato di bianco. per uso interno.

DE sportgerät, festliche tafel und konferenztisch in einem? ping meets pong macht's möglich. in das kugellager im zentrum der Ø2m tischplatte werden entweder das pingpong netz oder der Ø1m aufsatztisch frei drehbar eingesetzt. ping meets pong gibt es in blau und schwarz, den aufsatztisch in weiss. tischplatten melamin-beschichtet, aufbau stahl mit weisser pulverlack-beschichtung. indoor-möbel.

EN the all-in-one table for ping-pong, conferences and dinners: in the middle of the Ø2m table top a ball-bearing renders all this possible. the ping-pong net or the Ø1m accessory turntable insert freely rotatable into the bearing. ping meets pong is available in blue and black, the turntable in white. plates are melamine coated, table base is white powder coated steel. for indoor use only.



2
ping meets pong

information

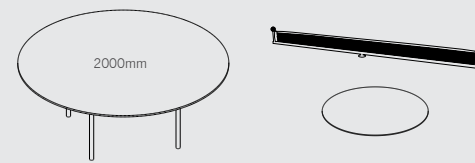

ping meets pong

2 BLUPINGPONG * ping meets pong blue, 1pc
3 NEROPINGPONG * ping meets pong black, 1pc

* fino ad esaurimento scorte | solange vorrat reicht | while stock last